

## VDW 1005

### Options Optionen

- > Hydraulic or electric shifting  
Hydraulische oder elektrische  
Schaltung
- > Mounting plates  
Montageplatten
- > Speed measuring  
Drehzahlmessung
- > Pendulum part  
Kardangelenk
- > Path measurement for relative  
adjustment  
Wegmessung für  
Relativverschiebung



X-SERIES



VIBRATION HEADS



CORING HEADS



DOUBLE HEAD  
DRILLING SYSTEMS



ROTARY HEADS  
FOR PILE RIGS



DRILLING  
ACCESSORIES

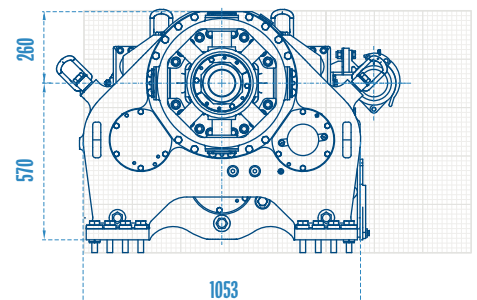
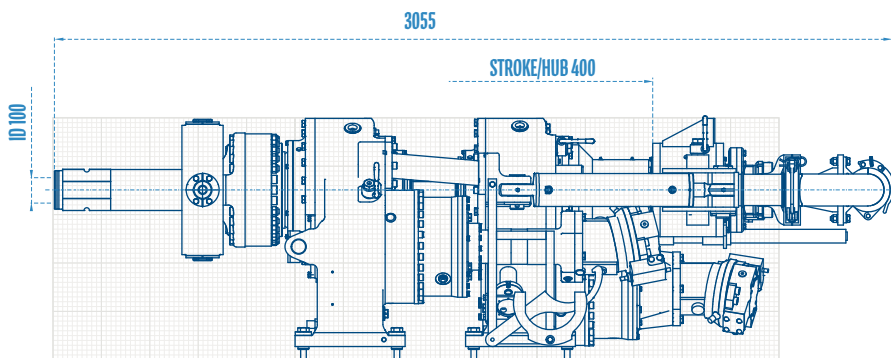

Technical Specifications are subject to modifications without prior notice and incurring responsibility for machines previously sold. The shown machines may have optional equipment. Technical data do not consider power losses. Error misprints reserved. / Technische Änderungen ohne Vorankündigung und Verpflichtung gegenüber früher gelieferten Geräten. Die abgebildeten Geräte können Sonderausstattungen haben. Technische Daten ohne Berücksichtigung des Wirkungsgrades. Irrtum und Druckfehler vorbehalten.



3400 kg **Weight** Gewicht  
500 kN **Traction** Zugkraft

**Gear box 1 / Casing VDW 1005**  
**Getriebe 1 / Rohr**

**Gear box 2 / Auger VDW 1005**  
**Getriebe 2 / Schnecke**

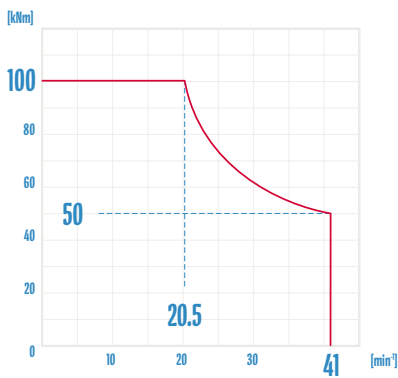

p = 320 bar & Q = 400 l/min

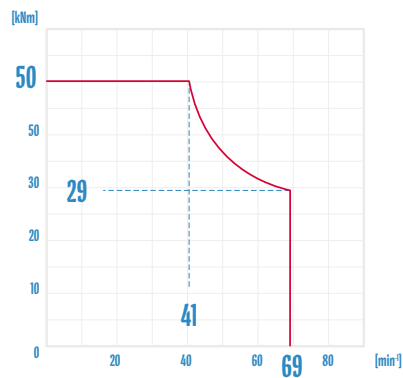

p = 320 bar & Q = 400 l/min